

# JOIST

SICHER IST DAS:  
DAS ORIGINAL

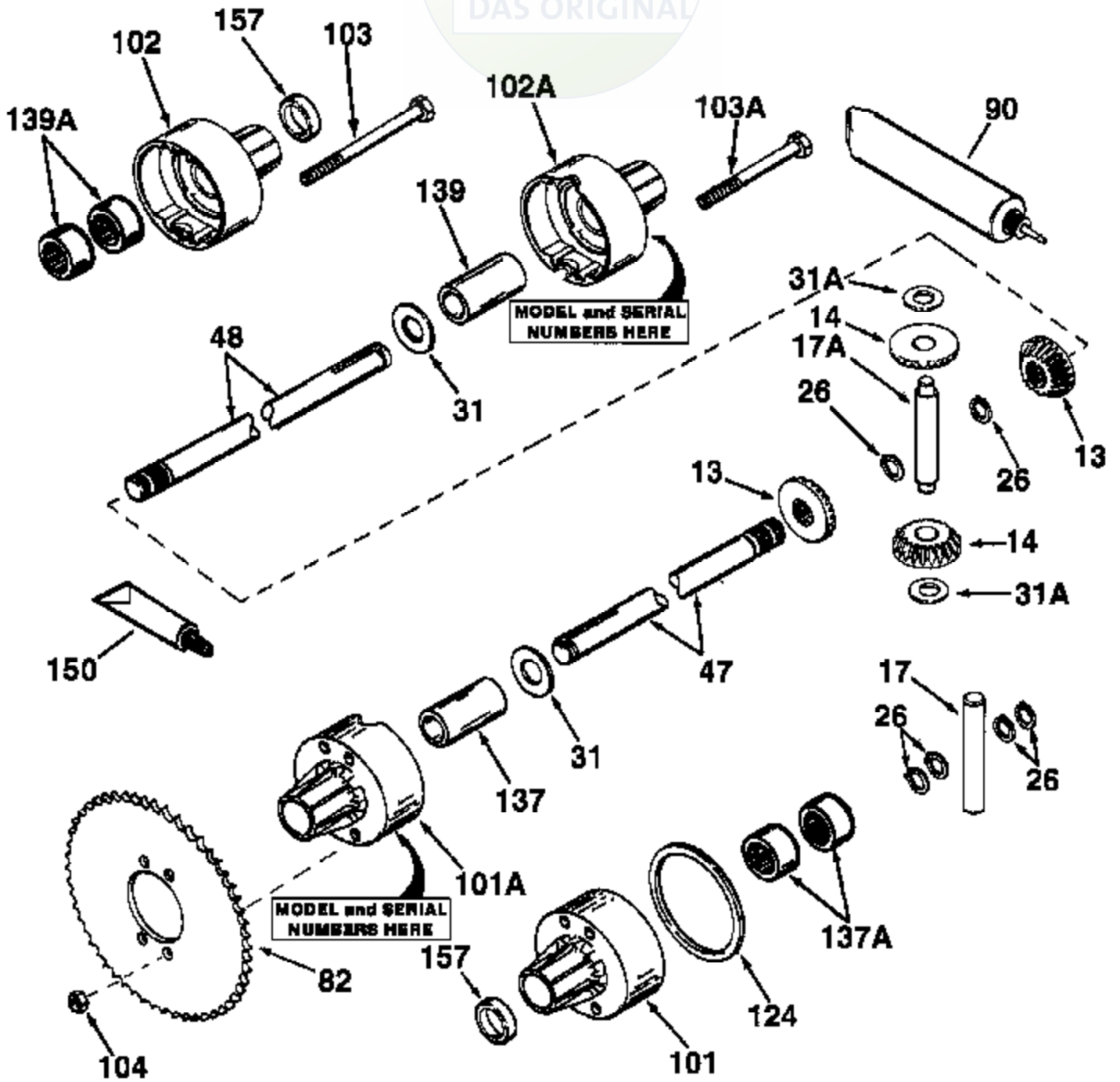

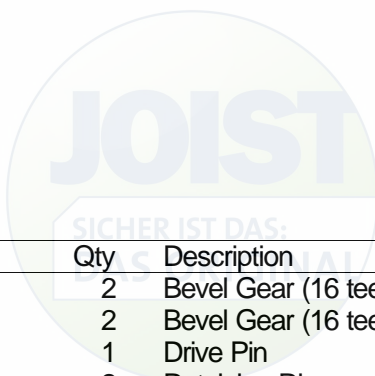





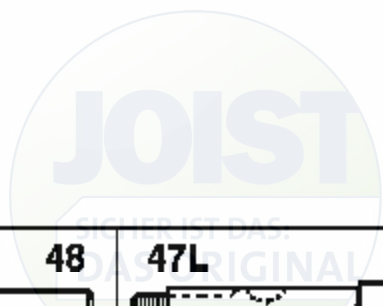



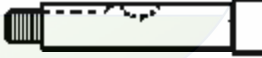
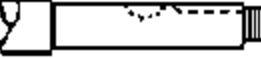
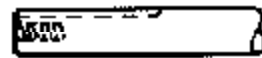



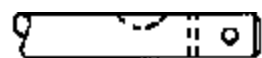
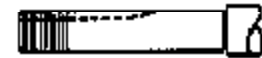
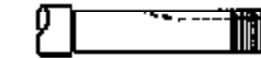
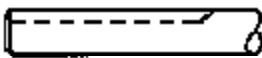
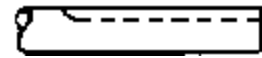
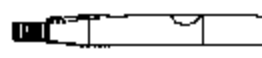
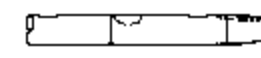

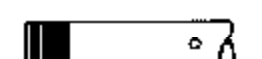
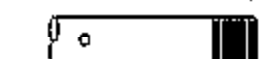

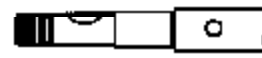

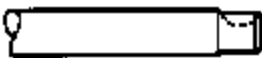

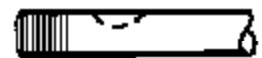

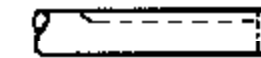
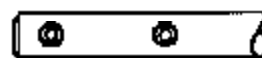
| Ref # | Part Number | Qty | Description                              |
|-------|-------------|-----|--|
| 13    | 778326      | 2   | Bevel Gear (16 teeth-steel)(Incl. 14)    |
| 14    | 778326      | 2   | Bevel Gear (16 teeth-steel)(Incl. 13)    |
| 17A   | 786093      | 1   | Drive Pin                                |
| 26    | 792018      | 2   | Retaining Ring                           |
| 31    | 780045      | 2   | Thrust Washer                            |
| 31A   | 780096      | 2   | Flat Washer (.625 ID)                    |
| 82    | 786041A     | 1   | Optional Sprocket (45 teeth - 7.389" OD) |
| 82    | 786042      | 1   | Optional Sprocket (40 teeth - 6.650" OD) |
| 82    | 786043      | 1   | Optional Sprocket (54 teeth - 8.823" OD) |
| 82    | 786051      | 1   | Optional Sprocket (60 teeth - 9.841" OD) |
| 82    | 786070      | 1   | Optional Sprocket (48 teeth - 7.920" OD) |
| 90    | 788067B     | 1   | Grease (32 oz. bottle Bentonite greas e) |
| 101A  | 775014      | 1   | Differential Carrier (Incl. 137)         |
| 102A  | 775015      | 1   | Differential Carrier (Incl. 139)         |
| 103A  | 792104A     | 2   | Screw 5/16-18 X 2"                       |
| 103   | 792044      | 4   | Screw 5/16-18 x 3-15/16"                 |
| 104   | 792042      | 4   | Locknut 5/16-18                          |
| 137   | 780198      | 1   | Bushing 1.003"                           |
| 139   | 780198      | 1   | Bushing 1.003"                           |
| 157   | 788007      | 2   | Oil Seal 1"                              |

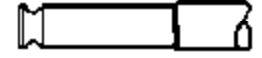
100-100-130 Peerless #1  
 Page 2 of 4

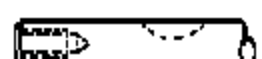
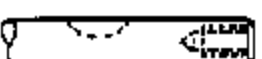

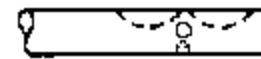
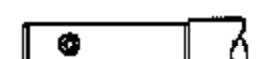
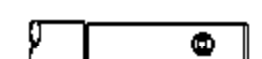
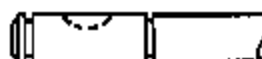
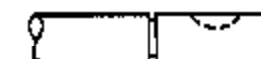
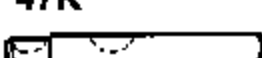
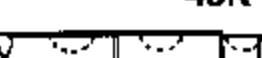
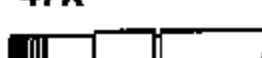
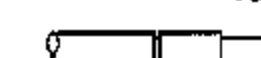
|   |   |  |   |
|---|---|--|---|
| <b>47</b><br>    | <b>48</b><br>    | <b>47L</b><br>   | <b>48L</b><br>   |
| <b>47A</b><br>   | <b>48A</b><br>   | <b>47M</b><br>   | <b>48M</b><br>   |
| <b>47B</b><br>   | <b>48B</b><br>   | <b>47N</b><br>   | <b>48N</b><br>   |
| <b>47C</b><br>   | <b>48C</b><br>   | <b>47P</b><br>   | <b>48P</b><br>   |
| <b>47D</b><br>   | <b>48D</b><br>   | <b>47Q</b><br>   | <b>48Q</b><br>   |
| <b>47E</b><br> | <b>48E</b><br> | <b>47R</b><br> | <b>48R</b><br> |
| <b>47F</b><br> | <b>48F</b><br> | <b>47S</b><br> | <b>48S</b><br> |
| <b>47G</b><br> | <b>48G</b><br> | <b>47T</b><br> | <b>48T</b><br> |
| <b>47H</b><br> | <b>48H</b><br> | <b>47U</b><br> | <b>48U</b><br> |
| <b>47I</b><br> | <b>48I</b><br> | <b>47V</b><br> | <b>48V</b><br> |
| <b>47J</b><br> | <b>48J</b><br> | <b>47W</b><br> | <b>48W</b><br> |
| <b>47K</b><br> | <b>48K</b><br> | <b>47X</b><br> | <b>48X</b><br> |

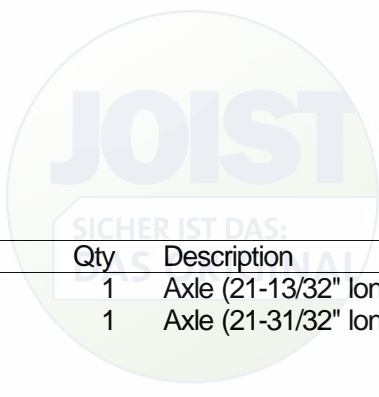

---

| Ref # | Part Number | Qty | Description           |
|-------|-------------|-----|-----------------------|
| 47C   | 775050      | 1   | Axle (21-13/32" long) |
| 48C   | 775051      | 1   | Axle (21-31/32" long) |

---

100-100-130  
Peerless #2

Page 4 of 4